

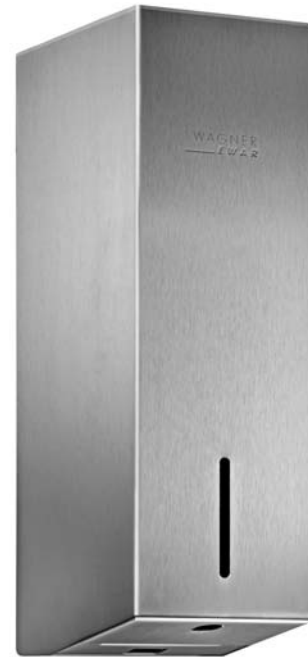

86 x 298 x 121 mm

950 ml tank

- Sensor disinfectant dispenser in robust, germ-reducing and easy-care stainless steel (AISI 316L).
- All-stainless steel housing; all corners fully welded, visible surfaces satin finished and brushed. Further available surfaces: see below.
- With EWAR® eModule touch-free operated disinfectant pump with 950 ml tank.
- Designed for standard disinfectants for hands.
- Inspection slot to indicate fill level.
- Accessible for refilling through lockable, hinged housing.
- Keyed alike cylinder lock in corrosion-resistant zinc die-casting.
- eModule battery-powered with two 1.5 V Baby/LR14 batteries. Power supply available as an option.
- Wear parts can be replaced as modules.
- Mounting: With two screws through key holes and one optional anti-theft hole in the back wall.
- Delivery includes fixing material and batteries.
- Weight, including single package: 1.8 kg



Suggested text for specifications:

Sensor disinfectant dispenser in stainless steel (AISI 316L) for surface mounting. All-stainless steel housing; all corners fully welded, visible surfaces satin finished and brushed. With touch-free operated disinfectant pump with 950 ml tank. Designed for standard disinfectants for hands. Inspection slot to indicate fill level. Accessible for refilling through lockable, hinged housing. Keyed alike cylinder lock in corrosion-resistant zinc die-casting. Delivery includes fixing material and batteries.

Dimensions: 86 x 298 x 121 mm

Article No. WP102e-7

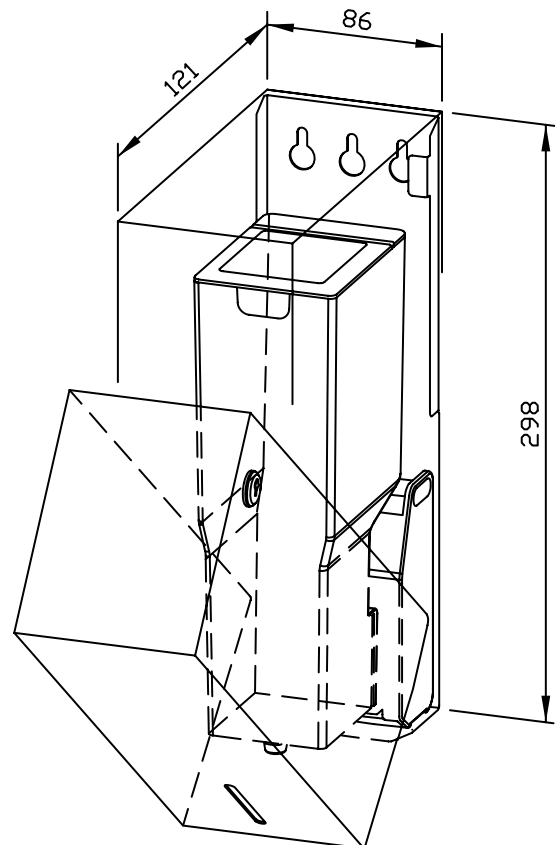

Options	ID No.
Power supply for eModule	923 060
Receptacle for WP/PP102e	937 139

Available surfaces	ID No.
satin finished (standard)	727 311
highly polished	731 311
(coloured) plastic powder-coating	728 311